



## C500B-LCD Instructions



**Nanjing Bigstone Electronic & Technology co.,Ltd**

# CONTENT

<b>ABOUT THE USER MANUAL</b> .....	2
<b>OUTLOOK AND SIZE</b> .....	2
MATERIAL AND COLOR.....	2
<b>BUTTON DEFINITION</b> .....	3
<b>FUNCTION SUMMARY</b> .....	3
FUNCTION SUMMARY.....	3
FULL VIEW AREA.....	5
NORMAL VIEW AREA.....	6
<b>NORMAL OPERATION</b> .....	6
1. ON/OFF.....	6
2. CURRENT DISPLAY.....	7
3. RIDING MODE SELECTION.....	7
4. SPEED DISPLAY.....	7
5. KM/H & MPH.....	8
6. BACKLIGHT INDICATOR.....	8
7. 6KM/H WORK.....	<b>ERROR! BOOKMARK NOT DEFINED.</b>
8. PAS LEVEL SELECTION.....	<b>ERROR! BOOKMARK NOT DEFINED.</b>
9. ERROR CODE INDICATOR.....	<b>ERROR! BOOKMARK NOT DEFINED.</b>
10. SET OPERATION.....	10
11. DISTANCE INDICATOR.....	11
12. TRIP TIME INDICATOR.....	13
13. BATTERY INDICATOR.....	13
14. MOBILE PHONE CHARGING INDICATOR.....	14
15. CABLE DEFINITION.....	14
16. AUTO SLEEP AFTER 5 MINUTES.....	15
<b>COMMON PROBLEMS &amp; SOLUTIONS</b> .....	15
<b>QUALITY &amp; WARRANTY</b> .....	15
QUALITY & WARRANTY.....	15
OTHER ITEMS.....	15
<b>ERROR CODE TABLE</b> .....	16

## ABOUT THE USER MANUAL

Dear users,

To ensure better performance of your e-bike, please read through the C500-LCD product introduction carefully before using it. We will inform you all the details concisely (including hardware installation, setting and normal use of the display) when using our display. Meanwhile, the introduction will also help you solve possible confusion and malfunction.

## OUTLOOK AND SIZE

### MATERIAL AND COLOR

C500B products are made of black ABS material and the bracket is made of nylon material. Under the temperature of -20 to 60°C, the shell material can ensure normal usage and good mechanical performance of the products.

Dimension figure (unit: mm)

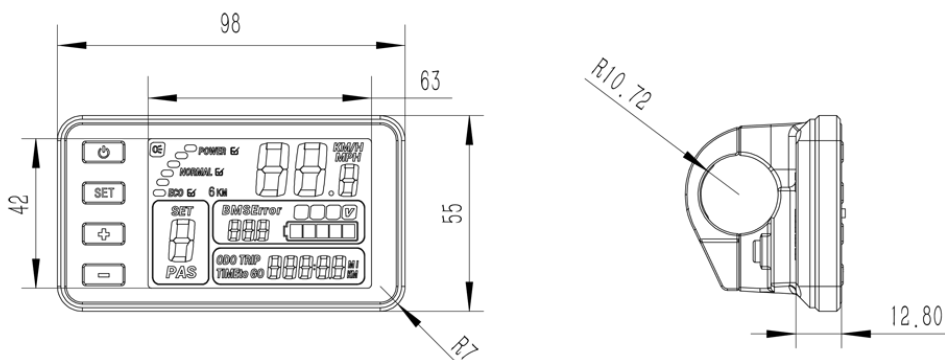

Address: NO.38 Ningliu Road, Pukou District, Nanjing City, China

Tel: 025-89618445

Fax: 025 – 58849541

Email: bigstone.ebike@gmail.com

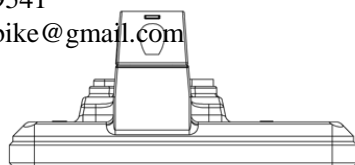

## BUTTON DEFINITION

C500B has four buttons including **ON/OFF**、**SET**、**UP** and **DOWN**.

“ON/OFF” names to “

The diagram illustrates the layout of four buttons on a control panel. On the left, the labels 'ON/OFF', 'SET', 'UP', and 'DOWN' are listed vertically. Dotted lines connect each label to its corresponding button on the right. The buttons are arranged vertically and contain the following symbols: a power icon (a circle with a vertical line and a dot), the word 'SET', a plus sign '+', and a minus sign '-'.

## FUNCTION SUMMARY

### FUNCTION SUMMARY

C500B provides a wide range of functions and indicators to fit the users' needs. The indicated contents are as below.

1. ON/OFF
2. Current display
3. Riding mode selection
4. Speed display
5. KM/H & MPH
6. Backlight indicator
7. 6KM/H work (**without this function for Lanfeng**)
8. PAS level selection
9. Error code indicator
10. SET operation
11. Distance indicator
  - 11.1 Total distance (ODO)
  - 11.2 Trip distance
  - 11.3 Remaining distance (**without this function by default**)
12. Trip time indicator
13. Battery indicator
  - 13.1 Battery residual capacity indicator
  - 13.2 Battery voltage
  - 13.3 Battery capacity percentage (**without this function by default**)
  - 13.4 Battery charging and discharging times (**without this function by default**)
14. Mobile phone charging indicator

15. Cable definition

16. Auto sleep after 5 minutes

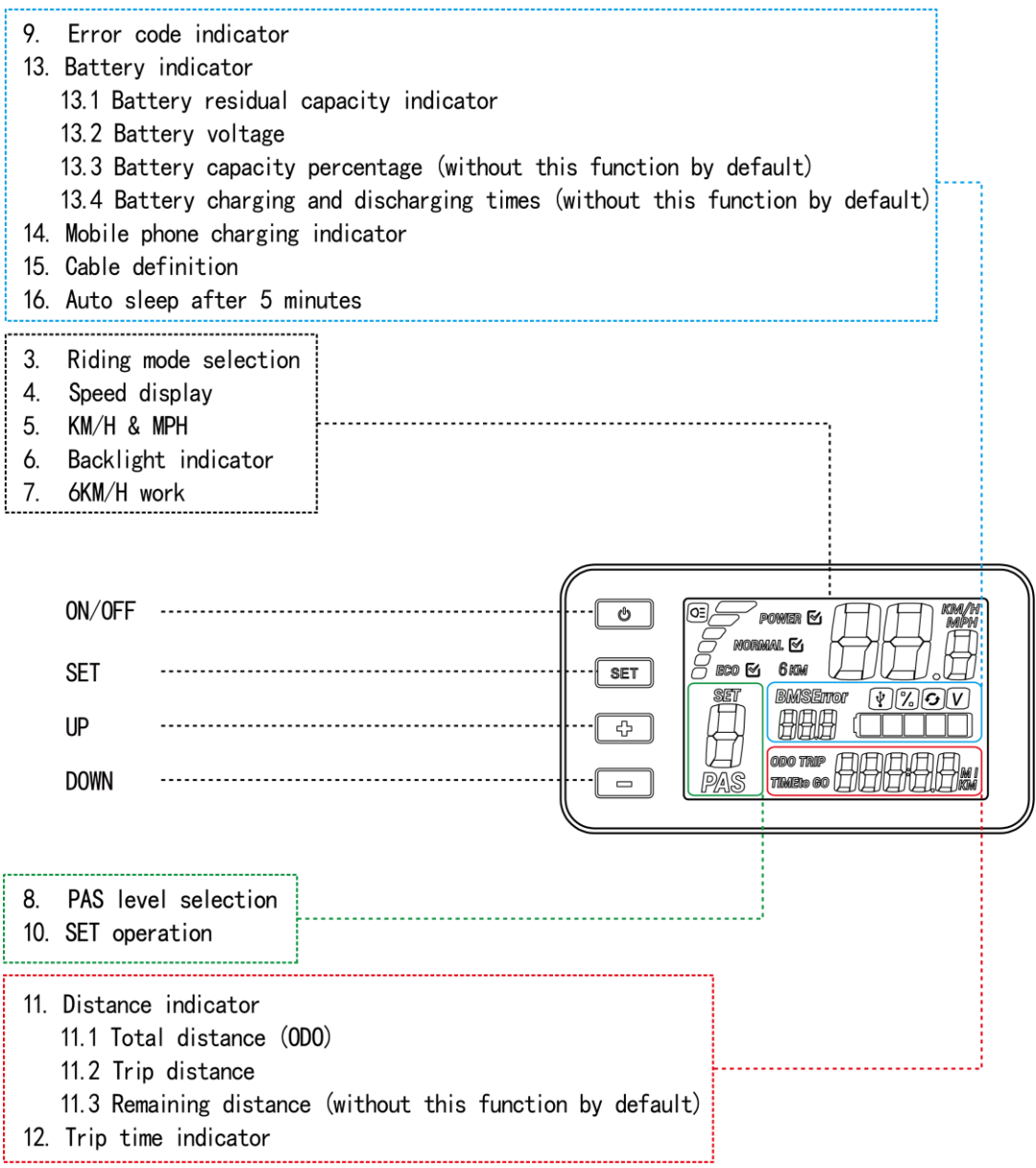

**FULL VIEW AREA**

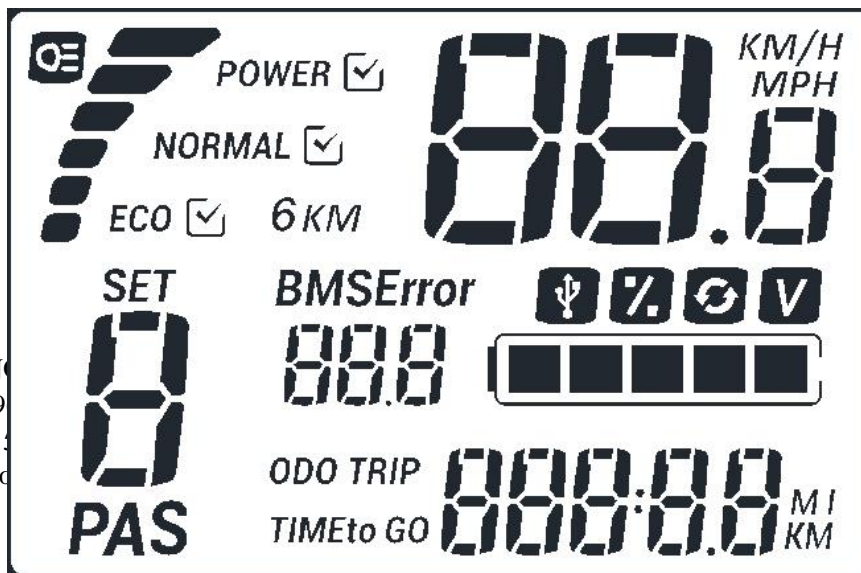

## NORMAL VIEW AREA

With the display on ,the default display are riding speed、 ODO、 PAS level、 battery indicator as show in fig below. Press **SET** to switch the display information. In turn shows: ODO, trip distance and trip time.

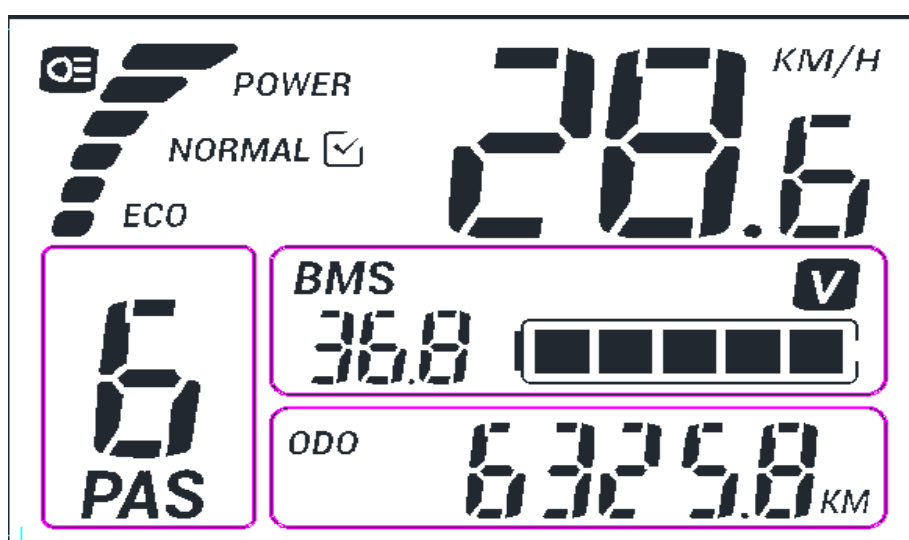

## NORMAL OPERATION

### 1. ON/OFF

Hold **ON/OFF** and start the display. The display will provide power for the controller. Hold **ON/OFF** again can open the backlight. With

display on, press **ON/OFF** for 3 seconds to turn off the power. With the display off, there is no battery consumption battery power. The leakage current is no more than 2 $\mu$ A.

※ The panel will go to sleep when the speed is 0 km/h for 5 minutes.

## 2. CURRENT DISPLAY

That represents the discharging current of the controller currently, each mark is 2A, six segments is  $\geq 12$ A.



## 3. RIDING MODE SELECTION

There are three modes for riding with arrow selection, including POWER, NORMAL and ECO. The default option is NORMAL.

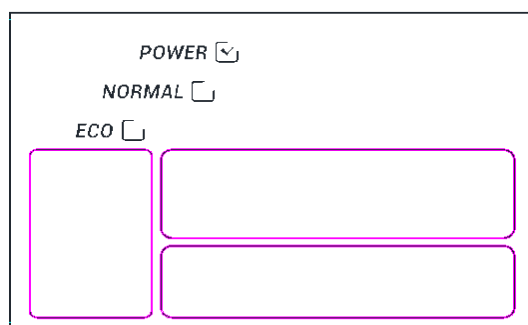

## 4. SPEED DISPLAY

The speed display is as below, and user can select KM/H or MPH in SET4.





## 5. KM/H & MPH

Select KM/H or MPH for the speed and mileage, display will be to the currently selected units display.

## 6. BACKLIGHT INDICATOR

With the power on, click the **ON/OFF** and turn on the backlight. Click it again and turn off the backlight.

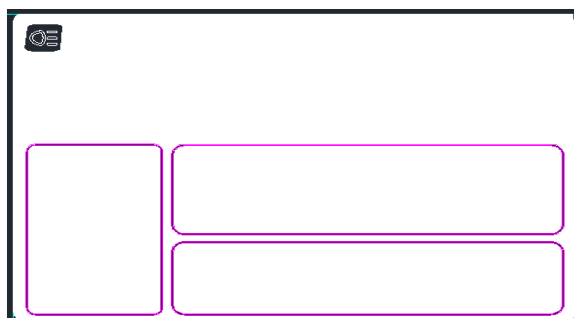

※If the e-bike has headlight, the controller will turn on/off the headlight at the same time of the backlight on/off (without this function by default)

## 7. 6KM/H WORK

Hold the **DOWN** for 2 seconds to get in 6km PAS work, and with your hand off, the 6km PAS work is released. The display is as below. (**without this**

function for Langfeng)



## 8. PAS LEVEL SELECTION

Click **UP** or **DOWN** to change the stages and output power ratio, the default mode is mode 6 and it's output power range from level 1 to level 6 (mode 3 and mode 9 can be customized), the default value is level 1.

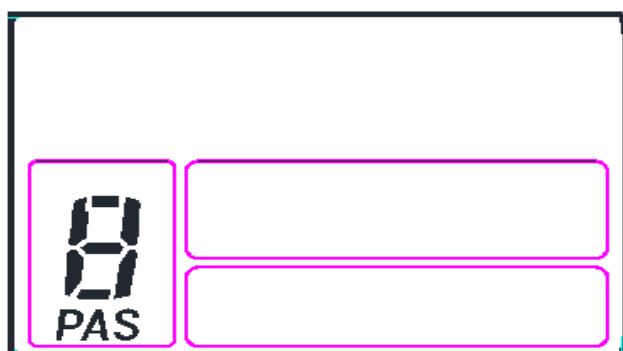

## 9. ERROR CODE INDICATOR

If there is something wrong with the electronic control system, the display will flash at 1 HZ and show the error code automatically. See the last page **Error code table** for details.

Address: NO.38 Ning  
 Tel: 025-89618445  
 Fax: 025 – 58849541  
 Email: bigstone.ebike@

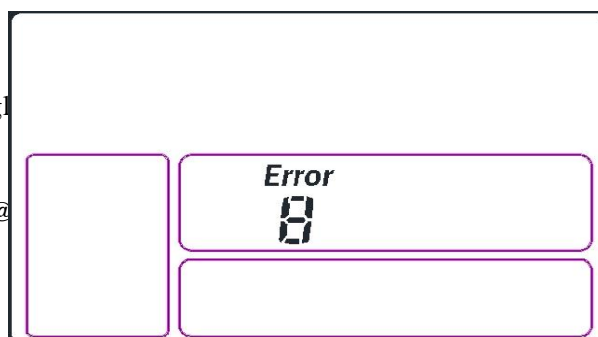

※ Display return to normal only after problem being fixed and e-bike will not run before fixing the problem.

## **10. SET OPERATION**

Hold the **SET** for 2 seconds and enter into the setting interface, then Number 8 is lighting, the display will flash at 1 HZ. Click the **SET** to cycle from 0 to 4 setting interface, press **UP** or **DOWN** to select the wanted parameter, and hold the **SET** for 1 second to exit.

### **10.1 :SET0: RIDING MODE SELECTION**

There are three modes for selected: POWER、NORMAL、ECO.

### **10.2: SET1: RESET TRIP DISTANCE TO 0**

Click the **DOWN** to reset the trip distance.

### **10.3 :SET2: MAX SPEED LIMITED SETTING**

The max speed is 25 km/h for the default, user can modify the value

of max speed, when the riding speed exceeds the set value, the controller will stop supplying power to the e-bike, in order to ensure the safety of rider.

※ The max speed value range from 20 km/h to 40 km/h. The max speed displays in speed display area.

#### **10.4 :SET3: WHEEL DIAMETER SETTING**

Select the suitable value to ensure the accuracy of display about speed and mileage.

#### **10.5 :SET4: KM/H & MPH**

Select MPH or KMH for the speed and mileage, display will be the currently selected units display.

※ Press **UP** or **DOWN** to select parameter, Hold **SET** for 1 second to save and exit.

### **11. DISTANCE INDICATOR**

With the display on, press **SET** to switch the display information, in turn shows: ODO, trip distance.

## 11.1 ODO

The ODO records the driving mileage from using, the accumulated value cannot be cleared.

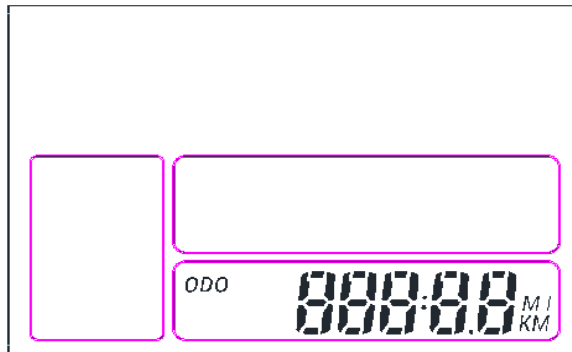

## 11.2 Trip distance

Trip distance is resetted by hand in the **SET 1 interface**. (when the riding mileage  $\geq 500$ km, it will be resetted automatically. The value will be accumulated without resetting.)

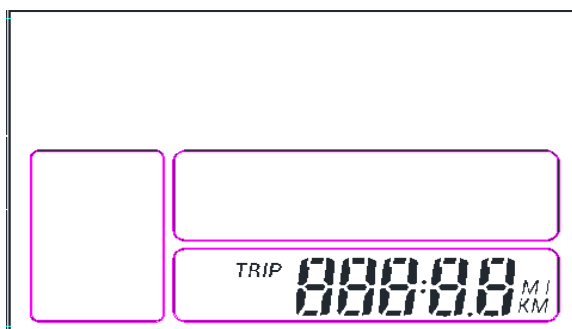

## 11.3 Remaining distance (the default is no)

This function need to be customized.

## 12. TRIP TIME INDICATOR

The riding time parameter is automatically reset after shut down.

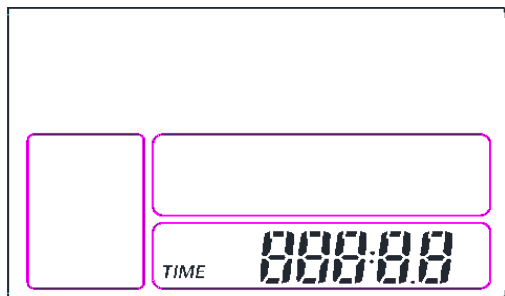

## 13. BATTERY INDICATOR

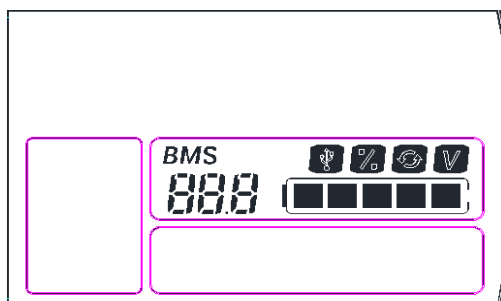

### 13.1 Battery residual capacity indicator

The battery frame have five segments, each segment represent 20% battery capacity. When the battery capacity is full, the five battery segments are all light. In low battery, the outside edge of the battery frame will flash. It indicates that the battery is severely low and needs to be recharged immediately.



Low battery flash

## 13.2 Battery voltage

It displays the current voltage of this battery.

## 13.3 Battery capacity percentage (without this function by default)

Display the percentage of battery capacity. This function needs customization.

## 13.4 Battery charging and discharging times (without this function by default)

This function needs customization.

※ The panel display the voltage for the default.

## 14. MOBILE PHONE CHARGING INDICATOR

Press **UP** and **SET** for 2s and the USB icon will light.



## 15. CABLE DEFINITION

- 1 Red: Battery +
- 2 Blue: Weak lock
- 3 Black: Battery-
- 4 Green: UART-RECEIVE (RXD)
- 5 White: UART- SEND (TXD)

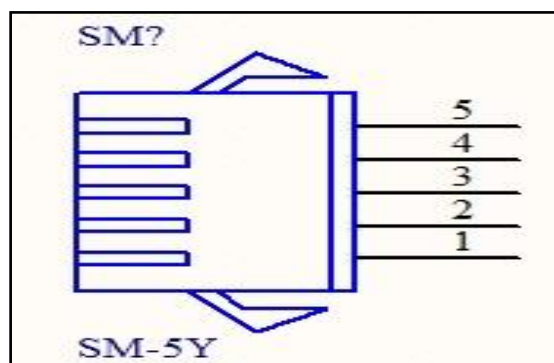

## 16. AUTO SLEEP AFTER 5 MINUTES

When the riding speed is 0 km/h for 5 minutes, the system will go to sleep automatically.

## COMMON PROBLEMS & SOLUTIONS

Q: Why the display is not able to start up?

A: Checking the connector that between display and controller.

Q: How to deal with the error code?

A: Fix it to the maintenance place immediately. If cannot be resolved, you can go to the electric vehicle repair points repair it in a timely manner.

## QUALITY & WARRANTY

### QUALITY & WARRANTY:

- 1、 Any quality problems in normal case and in guarantee period, our company will responsible for the warranty
- 2、 The warranty time is 18 months from date of purchasing.

### OTHER ITEMS:

The following items are not belong to warranty scope



1. It can not be demolished.
2. The damage caused by wrong installation or operation.
3. Shell is broken when display is out of the factory.
4. Wire is broken.
5. Force disaster (such as fire, earthquake, etc.) or natural disasters like lightning, etc caused by fault or damage.
6. Beyond Warranty period.

## **ERROR CODE TABLE**

The error code is corresponding with the fault definition.

Error code	definition
0	normal
1	Current error or MOS damaged
2	Throttle error(Start detection)
3	motor no phase position
4	Hall error
5	Brake error(Start detection)
6	Under voltage
7	Motor stalling
8	communication controller receiving error
9	communication display receiving error